



Características Técnicas
Technical Data

Corpo Compacto, Resistente a Impactos, com Isolamento Térmico e Elétrico
Compact body, Impact Resistance, Electric and Thermal Insulation
Punho de Forma Arredondada
Rounded Shaped Handle
Suporte Giratório e Mola Dianteira que Permite Maior Flexibilidade
Rotating Joint and Spring in the Handle Guarantees Great Ergonomics
Versátil/Compact
Versatile/Compact

Indicações
Recommendation

Serviços Médios
Medium Works



Serralherias - Locksmith's Works
Oficinas - Garage Indústrias - Industry
Trabalhos em geral para Aço Carbono, Alumínio* e Inox Works with Solid, Aluminium and Stainless Wires

Catálogo Digital
QR Code

Ciclo de Trabalho - Duty Cycle



CO₂

Argônio e Misturas
Argon Mixture

0,8 a 1,2

Arames (mm)
Wire (mm)

*Necessário substituir o tubo de contato e guia espiral. Verifique tabela de opcionais.

E05/22

Código/Code	Descrição/Description	Med./Mes.	Estoque/Stock
0500.4306	Tocha de Solda MIG/MAG SU 325 Rosca Quadrada/Euro Conector	3,00m	●
0500.4307	SU 325 MIG/MAG Welding Torch w/ Square Spiral Euro Connector	4,50m	●

Tocha/Torch MIG/MAG SU325





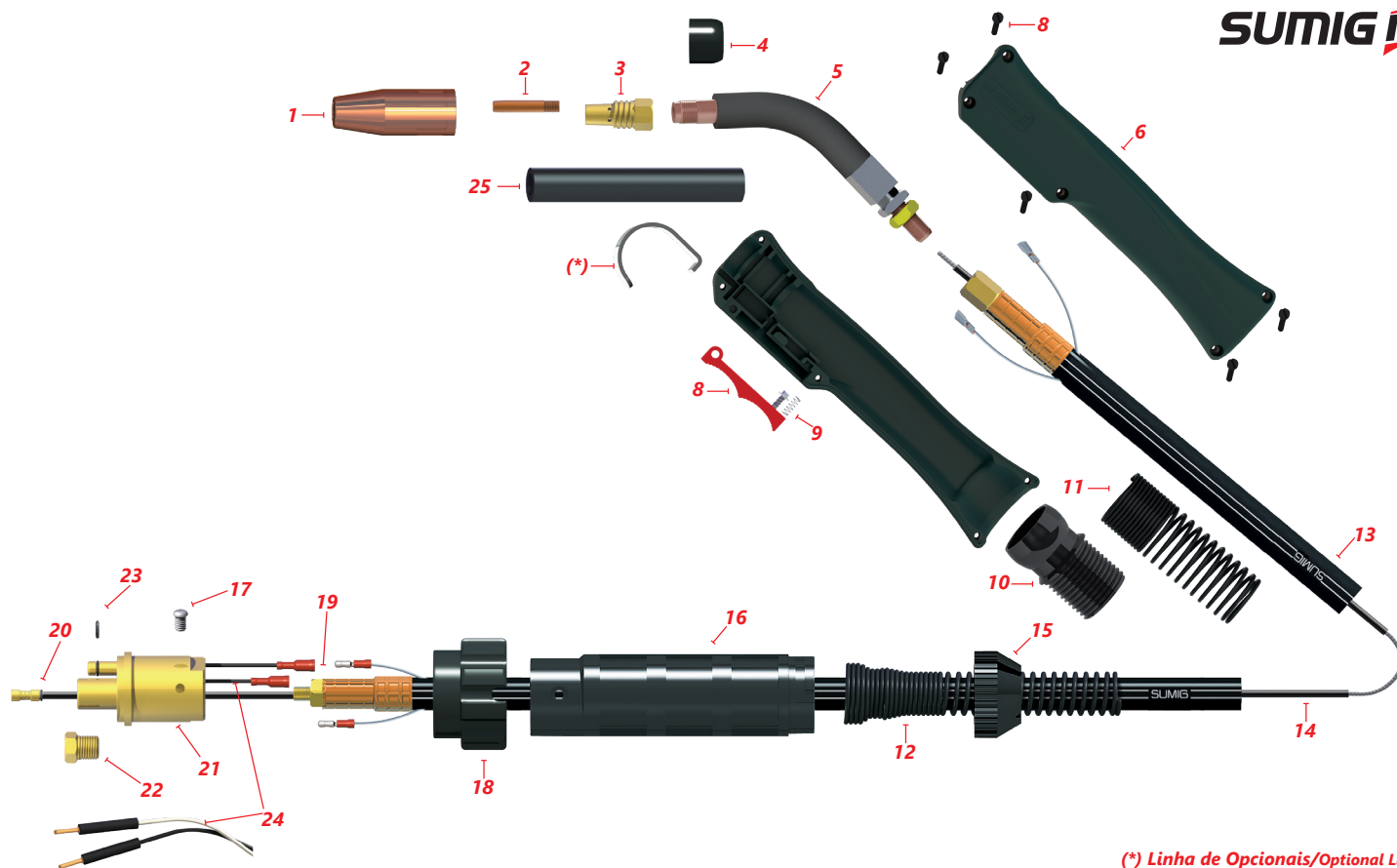

Legenda/Legend: ● Produto Regular ● Produto Sob Demanda







Foto/Photo	Pos.	Código/Code	Descrição/Description	Med./Mes.
	01	0500.2620	Ponteira Única Curta Rosca Quadrada Short Nozzle w/ Square Spiral	∅15x66mm
	02	0500.1080	Tubo de Contato Curto E-Cu E-Cu Short Contact Tip	0,80mm
		0500.1241		0,90mm
		0500.1081		1,00mm
		0500.1082		1,20mm
	03	0500.1101	Difusor de Gás Rosca Quadrada Gas Diffuser w/Square Spiral	38mm 5/16"
	04	0500.1103	Isolador do difusor de Gás Diffuser Insulator	
	05	0500.1104	Corpo da Tocha 50° (156 mm) 50° Torch Body	
	06	0502.2443	Punho da Tocha Torch Handle	
	07	0500.1106	Parafuso do Punho da Tocha Torch Handle Screw	

Foto/Photo	Pos.	Código/Code	Descrição/Description	Med./Mes.
	08	0500.1013	Acionamento Curto da Tocha Short Torch Trigger	
	09	0500.1014	Mola do Acionamento Curto Short Trigger Spring	
	10	0502.1448	Suporte Giratório do Punho Rotating Joint	
	11	0502.1456	Mola Dianteira do Cabo Cable Front Spring	
	12	0500.1110	Mola Traseira do Cabo Rear Cable Protection Spring	
	13	0510.1171	Cabo de Corrente Current Cable	2,80m
		0510.1170		4,30m

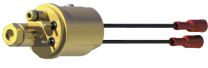

(*) Linha de Opcionais/Optional Line

Foto/Photo	Pos.	Código/Code	Descrição/Description	Med./Mes.
	14	0500.1115	Guia Espiral Preto 0,80/1,00mm Black Steel Liner 0,80/1,00mm	3,00m
		0500.1116		4,50m
	14	0500.1118	Guia Espiral Azul 1,20mm Yellow Steel Liner 1,20mm	3,00m
		0500.1119		4,50m
	15	0500.1026	Porca Fix. da Mola Euro Conector Euro Connector Spring Nut	
	16	0500.2836	Suporte do Euro Conector Euro Connector Support	
	17	0500.1028	Parafuso Fixador do Euro Conector Euro Connector Screw	
	18	0500.1029	Porca do Euro Conector Euro Connector Nut	

Foto/Photo	Pos.	Código/Code	Descrição/Description	Med./Mes.
	19	0500.1030	Porca de Encosto Nut	
	20	0500.1031	Anel O'Ring do Guia Espiral Steel Liner O-Ring	
	21	0500.2727	Euro Conector Macho Male Connector	
	22	0500.2603	Porca Fixadora do Guia Espiral Steel Liner Nut	
	23	0500.1034	Anel O'Ring do Gás Gas O-Ring	
	24	0801.5170	Conjunto Contato Retrátil Macho Lado da Tocha Spring Pin	
	25	0500.1937	Isolador do Corpo Insulator Body	